

**PALEARI**



**C  
A  
R  
L  
O**



**OFFERTA  
SPECIALE  
DINE GROUP**



**SCADENZA:  
DICEMBRE 2024**



**PALEARICARLO**

utensili per l'asportazione del truciolo

**PER INFO VISITA IL NOSTRO SITO**  
[www.palearicarlo.com](http://www.palearicarlo.com)

**Inquadra il codice  
QR e scarica tutti i  
nostri cataloghi**



**Inquadra il codice QR e  
verifica la disponibilità  
sul nostro shop**



# ALPHA MILL-X | SPALLAMENTO RETTO

• Valida sui diametri da 16 a 125

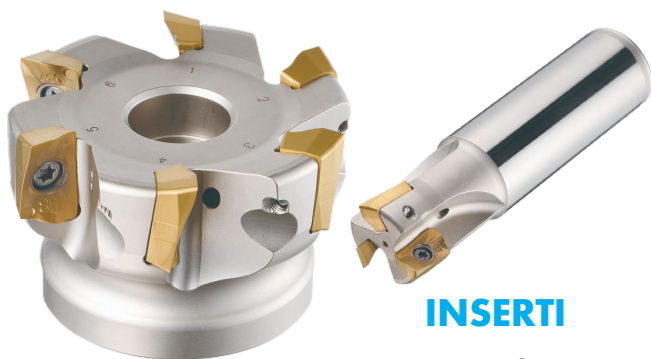

**FRESA**  
**AMXS** | CILINDRICA  
**AMXCM** | A MANICOTTO

### INSERTI

ADKT10..

ADKT12..

ADKT17..

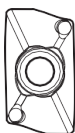

## INSERTI DISPONIBILI

**ADKT-MM**



**ADKT-ML**



INSERTI	P	M	S	K	N
ADKT	PC3700 PC5300 NCM535	PC9540	UNC840 UPC845	PC6510 NCM535	H01 (inserto ADHT)

## PROMOZIONE

Acquista 10  
 inserti a tagliente  
 e avrai il corpo  
 fresa a  
**1€/mm**

## INOLTRE

se aggiungi  
 altri 20 inserti  
 avrai la fresa a  
**1€**

Codice promo:

**OFADKT\***

### ROMPITRUCIOLI:

**ML** | PER MATERIALI DIFFICILI DA TAGLIARE

**MM** | PER FRESATURA GENERICA



Per maggiori informazioni  
 inquadra il Qr Code  
 con il tuo smartphone

• Aggiungere all'ordine codice promo  
 • Non applicabile a eventuali prezzi netti  
 Offerta valida solo su materiale disponibile a stock in italia

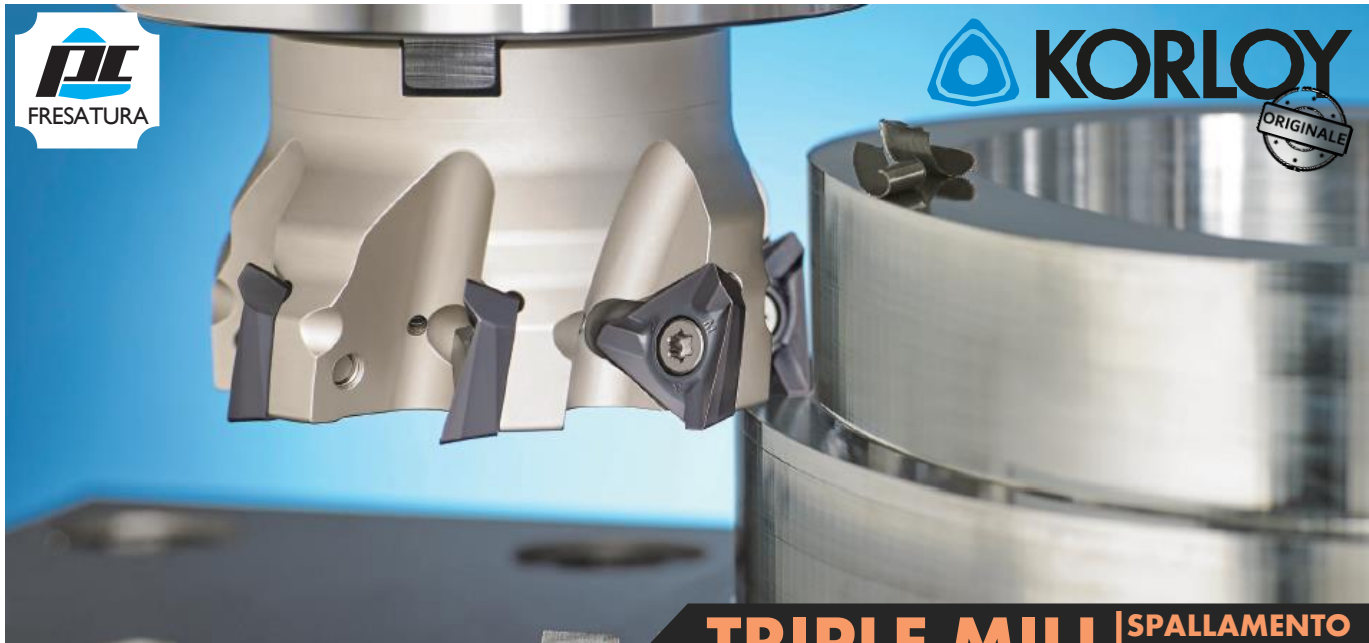

- Valida sui diametri da 22 a 125

**TRIPLE MILL** | SPALLAMENTO  
RETTO



**FRESA**

**TPMS** | CILINDRICA

**TPMCM** | A MANICOTTO

**INSERTI**

TNKT11..

TNKT16..

TNKT20..



**INSERTI DISPONIBILI**

**TNKT-MM**

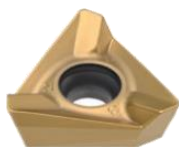

**TNKT-ML**

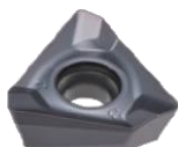

INSERTI	P	M	S	K
TNKT	PC3700 PC5300 PC5535	PC9540 PC5535	UNC840 UPC845	PC6510

**PROMOZIONE**

**Acquista 10  
inserti a tagliente  
e avrai il corpo  
fresa a  
1€/mm**

**INOLTRE**

**se aggiungi  
altri 20 inserti  
avrà la fresa a  
1€**

Codice promo:

**OFTNKT\***

**ROMPITRUCIOLI:**

**ML** | PER MATERIALI DIFFICILI DA TAGLIARE

**MM** | PER FRESATURA GENERICA



Per maggiori informazioni  
inquadra il Qr Code  
con il tuo smartphone

• Aggiungere all'ordine codice promo  
• Non applicabile a eventuali prezzi netti  
Offerta valida solo su materiale disponibile a stock in italia



• Valida sui diametri da 16 a 100

**HFMD-LN** | ALTO AVANZAMENTO



**FRESA**

**HFMDS** | CILINDRICA

**HFMDM** | TESTINA FILETTATA

**HFMDCM** | A MANICOTTO

**INSERTI**

**LNMX06..**

**LNMX10..**

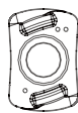

**INSERTI DISPONIBILI**

**LNMX:**

**MM**

**MF**

**ML**



INSERTI	P	M	S	K
LNMX	PC3700 PC5300	PC9540	UNC840 UPC845	PC6510

**PROMOZIONE**

**Acquista 10  
inserti a tagliente  
e avrai il corpo  
fresa a  
1€/mm**

**INOLTRE**

**se aggiungi  
altri 20 inserti  
avrà la fresa a  
1€**

Codice promo:

**OFHFMD\***

**ROMPITRUCIOLI:**

**ML** | PER MATERIALI DIFFICILI DA TAGLIARE

**MF** | PER LAVORAZIONI LEGGERE

**MM** | PER FRESATURA GENERICA



Per maggiori informazioni  
inquadra il Qr Code  
con il tuo smartphone

• Aggiungere all'ordine codice promo  
• Non applicabile a eventuali prezzi netti  
Offerta valida solo su materiale disponibile a stock in italia

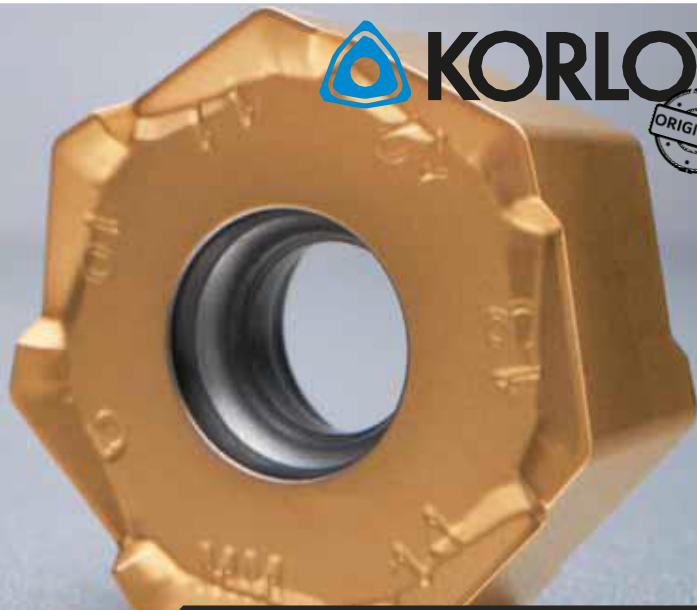
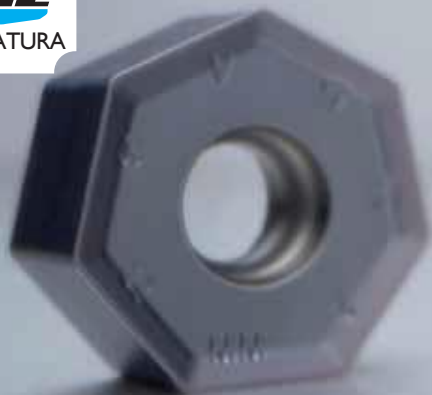

- Valida sui diametri da 50 a 100

**RM 14** | SPIANATURA

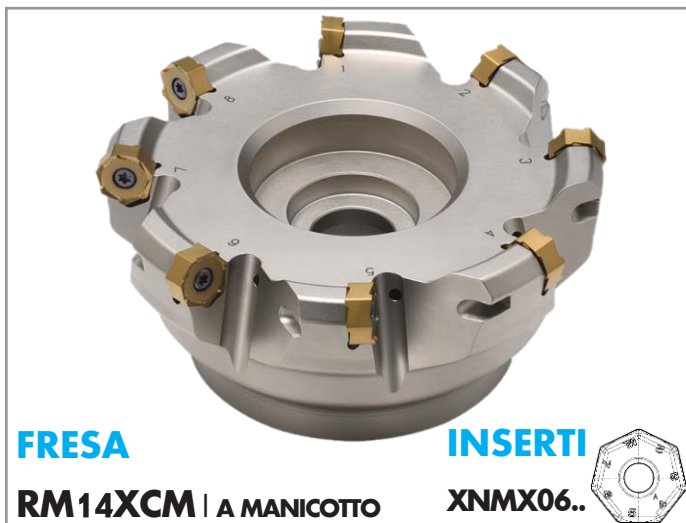

**FRESA**

**INSERTI**

**RM14XCM** | A MANICOTTO

**XNMX06..**

**INSERTI DISPONIBILI**

**XNMX:**

**HELIX TYPE (XNR)**  
**MM / ML**

**FLAT TYPE**  
**MM / ML**



INSERTI	P	M	S	K
XNMX	PC3700 PC5300 PC5535 NCM535	PC9540 PC5535	UNC840 UPC845	PC6510 NCM535

**PROMOZIONE**

**Acquista 10  
inserti a  
tagliante  
e avrai il  
corpo fresa a  
1€/mm**

Codice promo:

**OFRM14\***

**ROMPITRUCIOLI:**

**ML/MM (HELIX TYPE)** | PER LAVORAZIONI SU  
GHISA E MATERIALI FERROSI

**ML/MM (FLAT TYPE)** | PER LAVORAZIONI SU  
INOX



Per maggiori informazioni  
inquadra il Qr Code  
con il tuo smartphone

• Aggiungere all'ordine codice promo  
• Non applicabile a eventuali prezzi netti  
Offerta valida solo su materiale disponibile a stock in italia

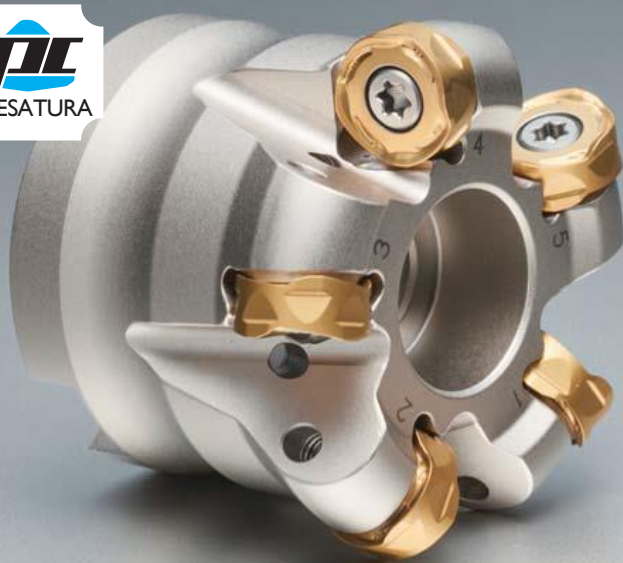

- Valida sui diametri da 32 a 125



**FRESA**

**RMRS** | CILINDRICA

**RMRCM** | A MANICOTTO

**INSERTI**

**RNMX12..**



**INSERTI DISPONIBILI**

**RNMX-ML**

**RNMX-MM**



INSERTI	P	M	S	K
RNMX	PC3700 PC5300	PC9540	UNC840 UPC845	PC6510

**RMR** | SPIANATURA

**PROMOZIONE**

**Acquista 10  
inserti a  
tagliante  
e avrai il  
corpo fresa a  
1€/mm**

Codice promo:

**OFRMR\***

**ROMPITRUCIOLI:**

**ML** | PER MATERIALI DIFFICILI DA TAGLIARE

**MM** | PER FRESATURA GENERICA



Per maggiori informazioni  
inquadra il Qr Code  
con il tuo smartphone

• Aggiungere all'ordine codice promo  
• Non applicabile a eventuali prezzi netti  
Offerta valida solo su materiale disponibile a stock in italia



## KING DRILL

### PROMOZIONE

**ACQUISTA IL CORPO PUNTA  
A UN PREZZO SPECIALE**

Codice promo:

**OFKING\***

DIAMETRI	K2D	K3D	K4D	K5D
DA D12 A D13,5	175,00 €	175,00 €	192,00 €	280,00 €
DA D14 A D20	198,00 €	198,00 €	218,00 €	320,00 €
DA D20,5 A D25	212,00 €	212,00 €	235,00 €	340,00 €
DA D25,5 A D30,5	230,00 €	230,00 €	255,00 €	370,00 €
DA D31 A D35	260,00 €	260,00 €	285,00 €	415,00 €
DA D35,5 A D40	272,00 €	272,00 €	300,00 €	435,00 €
DA D40,5 A D45	294,00 €	294,00 €	325,00 €	470,00 €
DA D45,5 A D50	310,00 €	310,00 €	340,00 €	495,00 €
DA D50,5 A D55	326,00 €	326,00 €	360,00 €	520,00 €
DA D55,5 A D60,5	345,00 €	345,00 €	380,00 €	550,00 €



Per maggiori informazioni  
inquadra il Qr Code  
con il tuo smartphone

• Aggiungere all'ordine codice promo  
• Non applicabile a eventuali prezzi netti  
Offerta valida solo su materiale disponibile a stock in italia





# KING DRILL

## PROMOZIONE

**Acquista 30 inserti SPMT / XOMT e riceverai il relativo corpo punta con uno Sconto speciale del 70%**

Codice promo:  
**OFKING\***



INSERTI	P	M	S	K	N
SPMT XOMT	PC3700 PC5300 PC5535 NCM535	PC9540 PC5300 PC5535	UPC845	PC6510 NCM535	H01 (SPET XOET)

Rompitruciolo	PD		LD		ND		RD
Caratteristiche	-Universale -Con avanzamenti e velocità media		-Ideale per acciai dolci e inossidabili -Lavorazioni leggere, con bassi avanzamenti e medie velocità		-Tagliente affilato per lavorare alluminio -Superficie inserto lappata Tolleranza E		-Tenuta ottimale grazie alla resistenza alle scheggiature ottimizzata
Inserto	Perimetrale	Centrale	Perimetrale	Centrale	Perimetrale	Centrale	Centrale
Forma							



Per maggiori informazioni  
inquadra il Qr Code  
con il tuo smartphone

• Aggiungere all'ordine codice promo  
• Non applicabile a eventuali prezzi netti  
Offerta valida solo su materiale disponibile a stock in italia



**TPDB/TPDC/TPDX**

**PROMOZIONE**

**Acquista 3 cuspidi e riceverai un extra sconto del 50% sul relativo corpo punta**

Codice promo:  
**OFTPD\***

**Offerta valida per tutti i diametri su tutte le punte**

**TPDB**

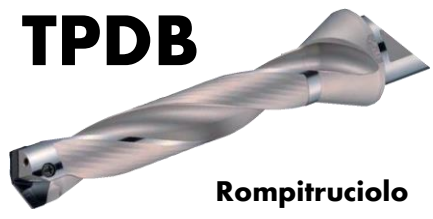

Rompitruciolo



USO GENERICO

**TPDC**



Rompitrucioli

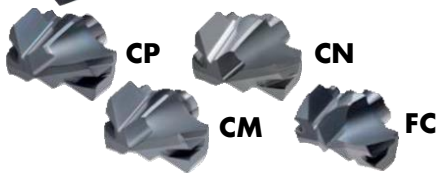

**TPDX**



Rompitruciolo

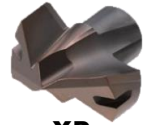

XP



Per maggiori informazioni inquadra il Qr Code con il tuo smartphone

• Aggiungere all'ordine codice promo  
• Non applicabile a eventuali prezzi netti  
Offerta valida solo su materiale disponibile a stock in italia



**TPDB/TPDC/TPDX**

**PROMOZIONE**

Codice promo:  
**OFTPD\***

**3xD  
&  
5xD**

**Acquista 6  
cuspidi e ricevi il  
relativo corpo  
punta a  
1,00€/mm**

**I  
N  
O  
L  
T  
R  
E**

**se aggiungi altre  
2 cuspidi  
ricevi il relativo  
corpo punta a  
1 €**

**8xD**

**Acquista 8 cuspidi e ricevi il  
relativo corpo punta a 1,00€/mm**

**TPDB**



Rompitruciolo

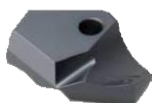

USO GENERICO

**TPDC**

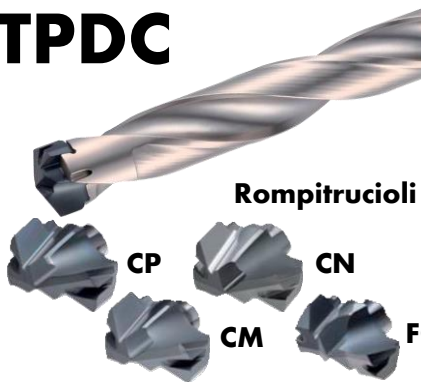

Rompitrucioli

CP

CN

CM

FC

**TPDX**



Rompitrucioli

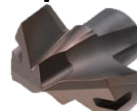

XP



Per maggiori informazioni  
inquadra il Qr Code  
con il tuo smartphone

• Aggiungere all'ordine codice promo  
• Non applicabile a eventuali prezzi netti  
Offerta valida solo su materiale disponibile a stock in italia

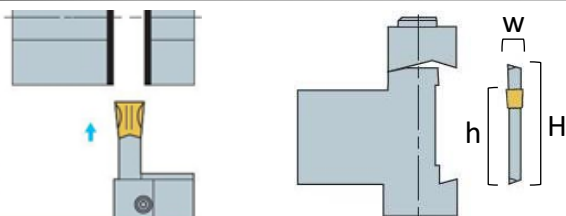
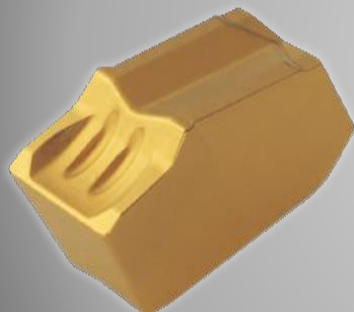

## LAME SPB-S

### PROMOZIONE

Acquista **20** inserti della serie SP... e avrai la relativa lama a

**1€/mm<sup>^</sup>**

Codice promo:

**OFSPB\***

<sup>^</sup> calcolato su altezza lama

Articolo	H	w	L	h (mm)	Inserto	
226-S	26	1,6	110	21	SP200..	
326-S	26	2,4	110	21	SP300..	
426-S	26	3,2	110	21	SP400..	
526-S	26	4,0	110	21	SP500..	
SPB	232-S	32	1,6	150	25	SP200..
	332-S	32	2,4	150	25	SP300..
	432-S	32	3,2	150	25	SP400..
	532-S	32	4,0	150	25	SP500..
	632-S	32	5,2	150	25	SP600..
	832-S	32	7,0	150	25	SP800..
	932-S	32	4,0	150	25	SP900..

Chiave: SW15-S (da ordinare separatamente)

INSERTI	P	M	S	K	H
SP...	NC3120 NC3225 NC3030 PC5300	PC5300 PC8110	PC8110	PC6510	H01

**Esempio di ordine:**

**20Pz SP300 NC3030 → listino -% sconto**

**1Pz SPB332-S**

**→ 32,00€**



Per maggiori informazioni  
inquadra il Qr Code  
con il tuo smartphone

• Aggiungere all'ordine codice promo  
• Non applicabile a eventuali prezzi netti  
Offerta valida solo su materiale disponibile a stock in italia

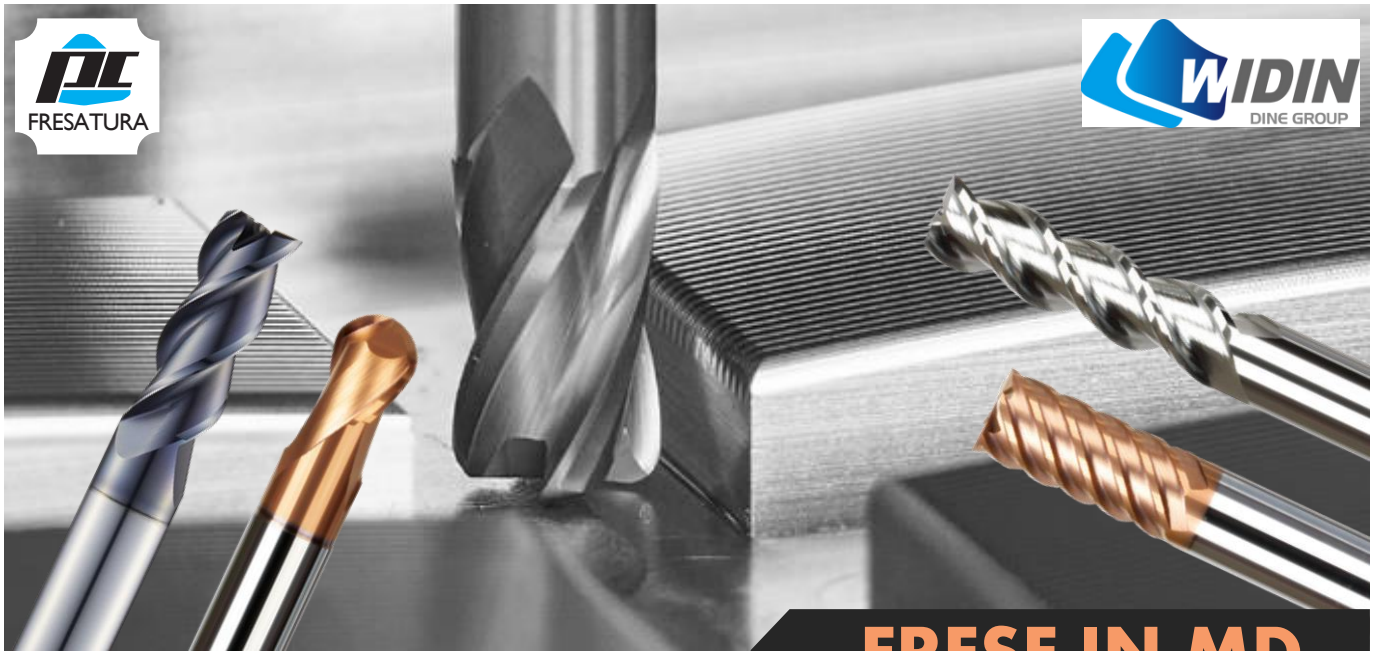

## FRESE IN MD

**PROMO VALIDA SULLE LINEE:**

**LINEA FRESE**

**X-STAR**

**LINEA FRESE**

**V-STAR**

**LINEA FRESE**

**ZAMUS THUNDER**

**LINEA FRESE**

**S-WING**

**LINEA FRESE**

**ALU-WAVE**

**PROMOZIONE**

**Acquista 6pz  
dello stesso  
articolo e  
1 lo paghi  
1€**

Codice promo:

**OFWID\***

**Esempio di ordine:**

**5Pz/SR504120 → listino -% sconto**

**1Pz/SR504120 → 1,00€**



Per maggiori informazioni  
inquadra il Qr Code  
con il tuo smartphone

• Aggiungere all'ordine codice promo  
• Non applicabile a eventuali prezzi netti  
Offerta valida solo su materiale disponibile a stock in Italia



Nuove frese ad alte prestazioni per lavorare materiali come aisi, superleghe e acciai



**KIT S-WING**

**PROMOZIONE**

**1 KIT**  
**composto da**  
**5 frese a soli**  
**205,00€**

Codice promo:

**OFWID\***

Cod.	D=D2	R	Utile	Scarico	L totale	Attacco
SR50406005F	6	0,5	15	22	60	WELDON
SR50408005F	8	0,5	20	27	70	
SR50410005F	10	0,5	25	33	75	
SR50412005F	12	0,5	30	40	80	
SR50416005F	16	0,5	42	52	100	



Per maggiori informazioni  
inquadra il Qr Code  
con il tuo smartphone

• Aggiungere all'ordine codice promo  
• Non applicabile a eventuali prezzi netti  
Offerta valida solo su materiale disponibile a stock in italia



# MANDRINI

## IDRAULICO

Codice promo:

**OFDIN\***

TIPO	Mandrini DHE	PREZZO
	BT40-DHE20-90	237,00 €
	BT50-DHE20-90	277,00 €
	SK40-DHE20-90	237,00 €
	SK50-DHE20-90	277,00 €
	HSK63A-DHE20-100	277,00 €

## PINZE ULTRA PRECISE

TIPO	Mandrini GSK	PREZZO
	BT40-GSK16-90	157,00 €
	BT40-GSK16-120	157,00 €
	BT40-GSK16-150	164,00 €
	BT40-GSK20-90	161,00 €
	BT40-GSK20-120	162,00 €
	BT50-GSK20-105	202,00 €
	BT50-GSK20-135	202,00 €
	BT50-GSK20-165	230,00 €
	BT50-GSK25-105	210,00 €
	BT50-GSK25-135	230,00 €
	BT50-GSK25-165	240,00 €
	SK40-GSK10-90	147,00 €
	SK40-GSK16-90	157,00 €
	SK40-GSK16-150	164,00 €
	SK40-GSK20-90	161,00 €
	SK50-GSK20-105	202,00 €
	SK50-GSK20-165	230,00 €
	SK50-GSK25-105	210,00 €
	SK50-GSK25-165	240,00 €
HSK63A-GSK16-120	180,00 €	
HSK63A-GSK20-120	187,00 €	

## FORTE SERRAGGIO

TIPO	Mandrini NPM	PREZZO
	BT40-NPM20-85	166,00 €
	BT40-NPM32-110	181,00 €
	BT50-NPM20-95	203,00 €
	BT50-NPM32-110	229,00 €
	SK40-NPM20-95	166,00 €
	SK40-NPM32-110	181,00 €
	SK50-NPM20-100	203,00 €
	SK50-NPM32-100	229,00 €
	HSK63A-NPM20-100	213,00 €
	HSK63A-NPM32-120	249,00 €



Per maggiori informazioni  
inquadra il Qr Code  
con il tuo smartphone

• Aggiungere all'ordine codice promo  
• Non applicabile a eventuali prezzi netti  
Offerta valida solo su materiale disponibile a stock in italia



## SET SK40-DHE

## SET Mandrino idraulico DHE

Codice promo:  
**OFDHE\***



## PROMOZIONE

**1 MANDRINO +  
5 PINZE A UN  
PREZZO SPECIALE**

CODICE KIT	COMPOSTO DA:	PREZZO KIT
SK-DHE12(SET)	SK40-DHE12-90	260,00€
	DHC12-3(P)	
	DHC12-4(P)	
	DHC12-5(P)	
	DHC12-6(P)	
SK-DHE20(SET)	DHC12-8(P)	290,00€
	SK40-DHE20-90	
	DHC20-6(P)	
	DHC20-8(P)	
	DHC20-10(P)	
	DHC20-12(P)	
	DHC20-16(P)	

**Offerta valida fino ad esaurimento scorte**



Per maggiori informazioni  
inquadra il Qr Code  
con il tuo smartphone

• Aggiungere all'ordine codice promo  
• Non applicabile a eventuali prezzi netti  
Offerta valida solo su materiale disponibile a stock in italia





## MICRO BORING

## PROMOZIONE

**ACQUISTA 1 TESTINA + 1 CARTUCCIA  
E AVRAI IL RELATIVO MANDRINO  
A SOLO 1€**

Codice promo:  
**OFBAR\***

**CONTROLLA SUL  
CATALOGO TUTTE LE  
MISURE E COMPONENTI  
IL TUO SISTEMA  
MODULARE**

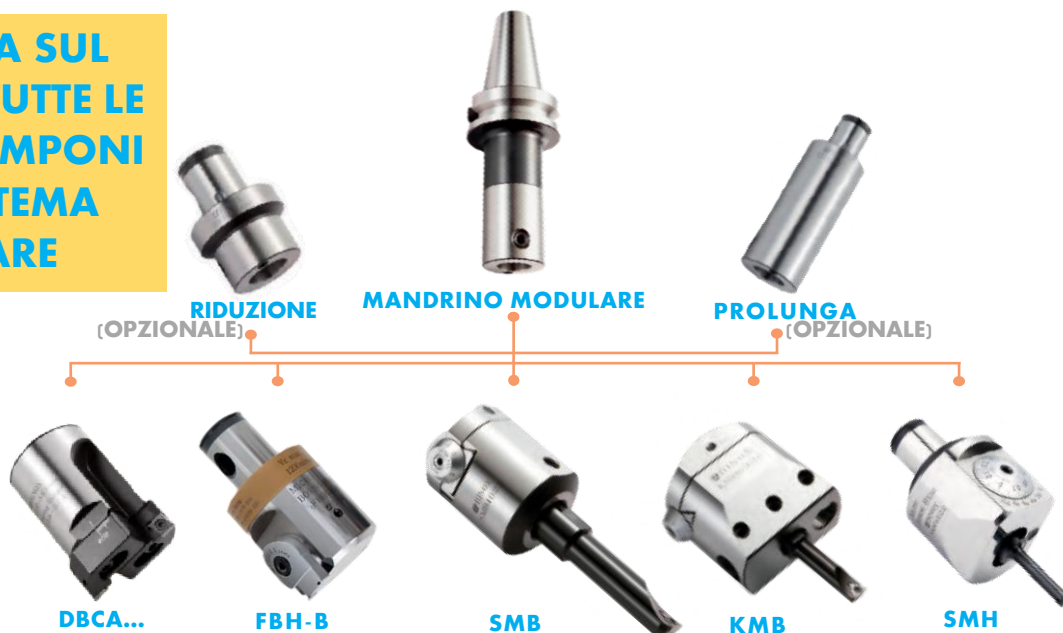

## TIPI DI TESTINE



Per maggiori informazioni  
inquadra il Qr Code  
con il tuo smartphone

• Aggiungere all'ordine codice promo  
• Non applicabile a eventuali prezzi netti  
Offerta valida solo su materiale disponibile a stock in Italia



# PALEARICARLO



#### GENOVA

Calata Boccardo 8  
Genova  
010 65 92 011  
[genova@bierredi.it](mailto:genova@bierredi.it)

#### LA SPEZIA

via Ruini 3  
Vezzano Ligure (SP)  
0187 982 128  
[spezia@bierredi.it](mailto:spezia@bierredi.it)

#### SAVONA

via Italia 4  
Vado Ligure (SV)  
019 21 60 196  
[savona@bierredi.it](mailto:savona@bierredi.it)

#### ALESSANDRIA

via della Plastica 6  
Alessandria  
0131 249 883  
[alessandria@bierredi.it](mailto:alessandria@bierredi.it)

#### CUNEO

via della Motorizzazione 2e  
Madonna dell'Olmo (CN)  
0171 413 333  
[cuneo@bierredi.it](mailto:cuneo@bierredi.it)



# PALEARICARLO

Via Asmara, 7

21052 Busto Arsizio - Italia

T +39 0331 350 000

[ordini@palearicarlo.com](mailto:ordini@palearicarlo.com)

[www.palearicarlo.com](http://www.palearicarlo.com)